

SPECIFICATIONS规格:

Center frequency中心频率 (KHz)	40.0±1.0KHz
Sound Pressure Level声压 (dB) 0dB=0.0002 μ bar	≥115dB
Sensitivity灵敏度 (dB) 0dB=1volt/ μ bar	≥-65dB
Beam Angle指向角 -6dB	80°typical
Capacitance静电容量 (pF)	2100±20%pF
Max. Driving Voltage最大驱动电压(RMS)	20Vrms
Working Temperature工作温度(°C)	-20 to +70°C
Storage Temperature贮存温度(°C)	-30 to +80°C
Function(功能)	Transmitter & Receive

DIMENSIONS尺寸:

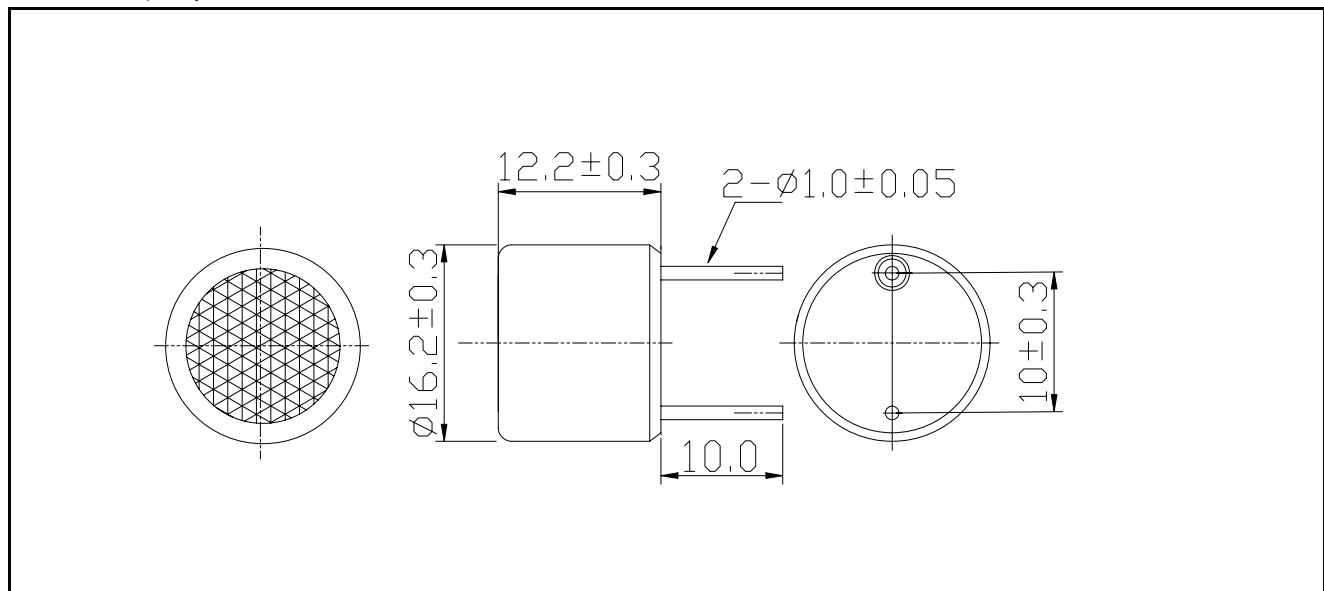

TESTING CONDITION AND INSTRUMENT测试条件和仪器

ITEM项目	TESTING CONDITION测试条件	TESTING INSTRUMENT测试仪器
Center frequency中心频率	T=25~30°C H ≤85%RH	压电换能器阻抗分析系统II型
Sound Pressure Level声压	at 40KHz/30cm/10Vrms	SoundCheck 4.1
Sensitivity灵敏度	at 40KHz	SoundCheck 4.1
Beam Angle指向角	-----	SoundCheck 4.1
Capacitance静电容量	at 1KHz/1V 25°C	ZL5智能LCR测量仪

TYPICAL CURVE 典型曲线

Frequency 频率

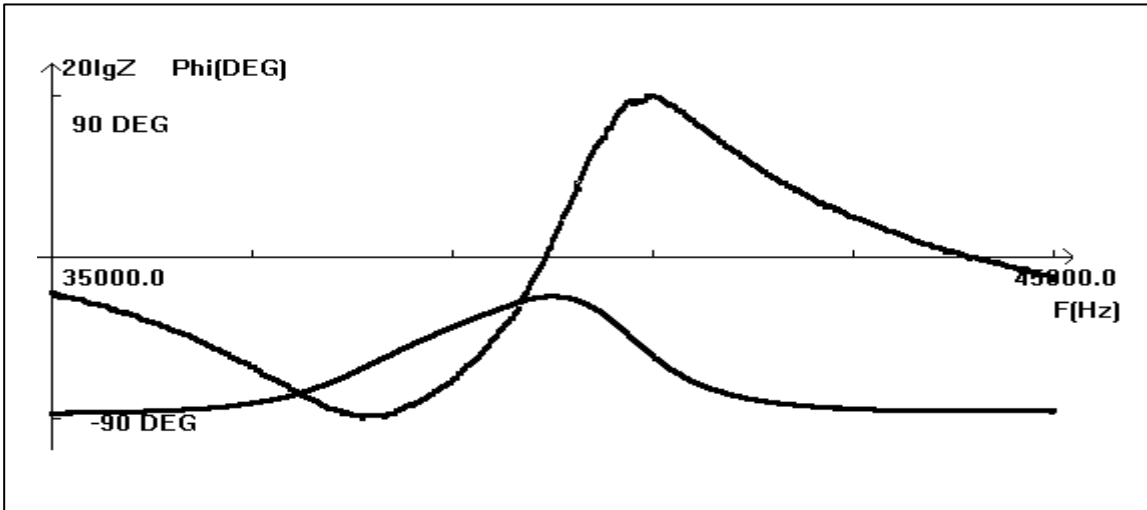

Transmitter SPL 发射声压

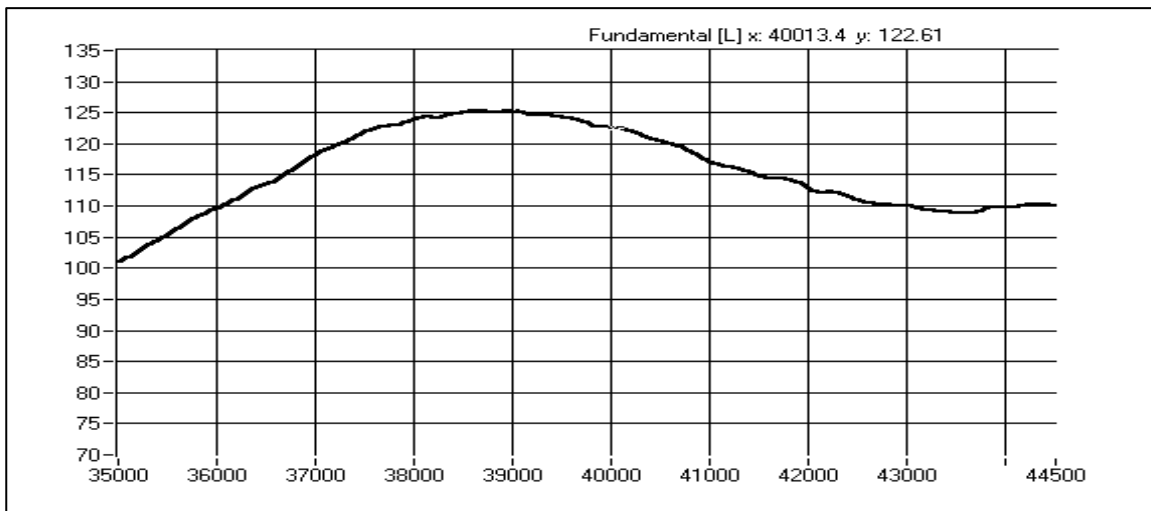

Beam Angle 指向角

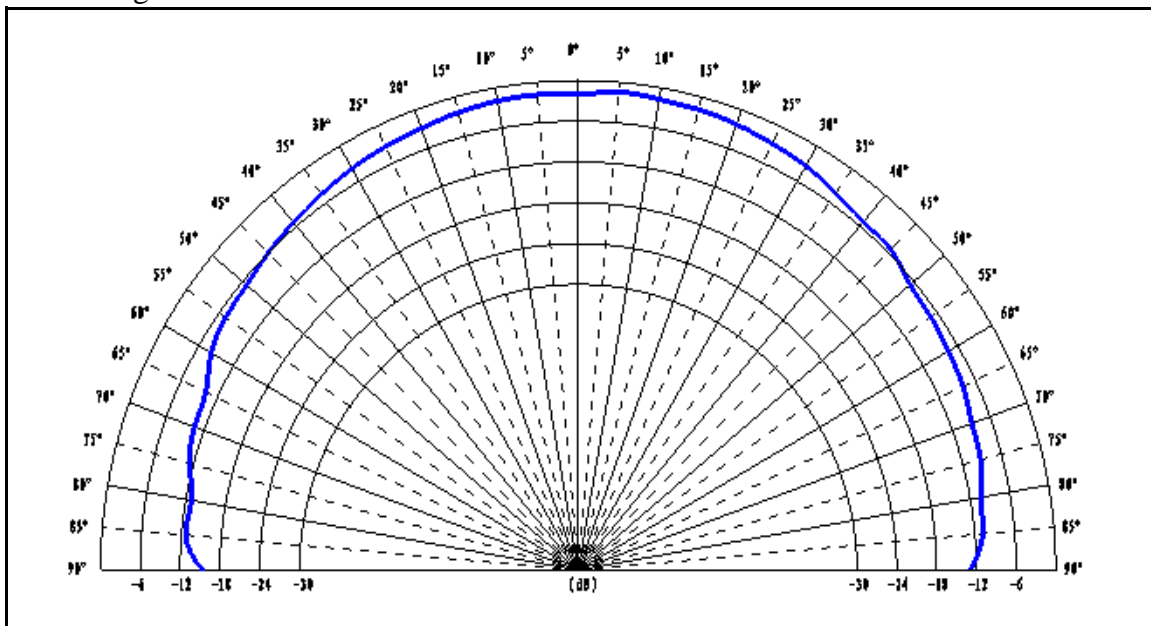

ENVIRONMENT CHARACTERISTICS环境特征

<p>High and low temperature(from-20°C to +70°C at a relative humidity of 30%) 温度变化范围: -20°C~+70°C相对湿度: 30%</p>	<p>Sound pressure level and peak sensitivity shall not change by more than 15dB in the temperature range from the high temperature to the low temperature 温度变化范围内, 声压和灵敏度峰值的变化: ≤15dB</p>
<p>Humidity of 10% to 90% at the temperature of 25°C 温度: 25°C湿度变化范围: 10%~90%</p>	<p>Sound pressure level and sensitivity shall not change by more than 6dB in the humidity range 湿度变化范围内, 声压和灵敏度的变化≤6dB</p>
<p>Storage at +80°C for 96 hours and at -30°C for 96hours followed by a normalization period at 25°C. As shown in FIG1. 存储: 升温到+80°C保持96小时, 降温到-30°C保持96小时, 然后升温到室温25°C。如图FIG1</p>	<p>All sensitivity or sound pressure level shall be within 3 dB of the specified values after the device is subjected to any or all of the conditions. 装置遭受所有四种情况或者其中任何一种情况, 所有灵敏度或声压水平应在指定值的±3 dB范围以内</p>
<p>Operation at 95% relative humidity and 40°C for 100 hours, followed by a normalization period of 24hours at 30% and 25°C. As shown in FIG2. 工作: 在相对湿度95% 和温度+40°C条件下保持100小时, 然后在湿度30%和温度25°C条件下保持24小时。如图FIG2</p>	
<p>Vibration at 10Hz to 55Hz ,1.5mm amplitude. 1 minute sweep. X,Y,Z,3 each axis for 3 hours. 振动: 频率10Hz to 55Hz ,振幅1.5mm, 扫频1分钟, X, Y, Z三轴, 每轴3小时。如图FIG3</p>	
<p>Drop Test:Drop a sensor from the height of 700mm onto the surface of 10mmthick wooden board(FIG4) .Two directions; Fall the body sport freely. 跌落: 从700mm的高度自由跌落到10mm厚度的木地板上, 任意二个方向进行。如图FIG4</p>	

FIG1 TEMP. TEST

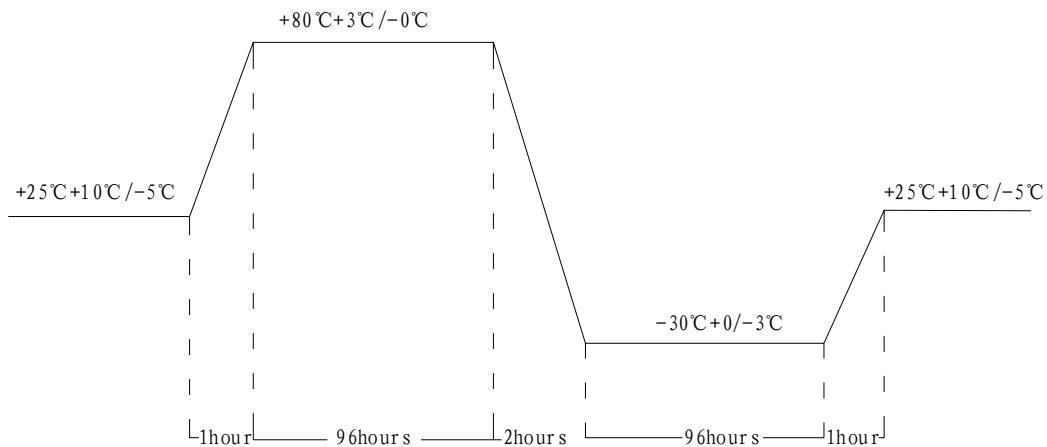

FIG 2 TEMP. /HUMIDITY TEST

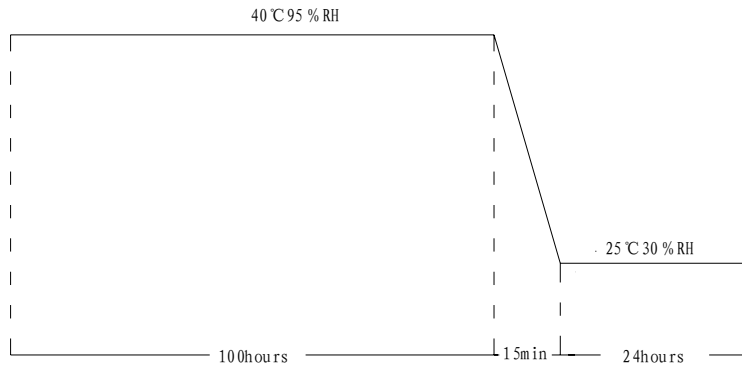

FIG3 VIBRATION TEST

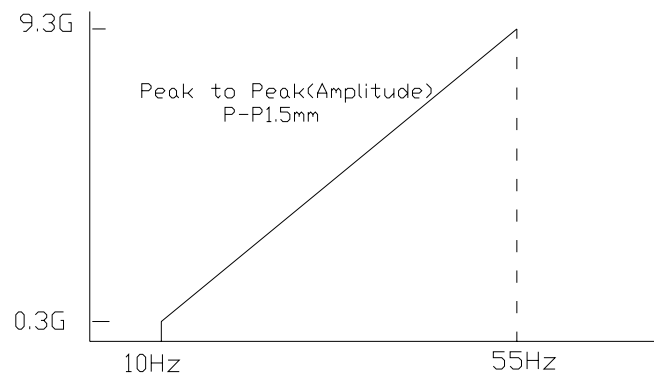
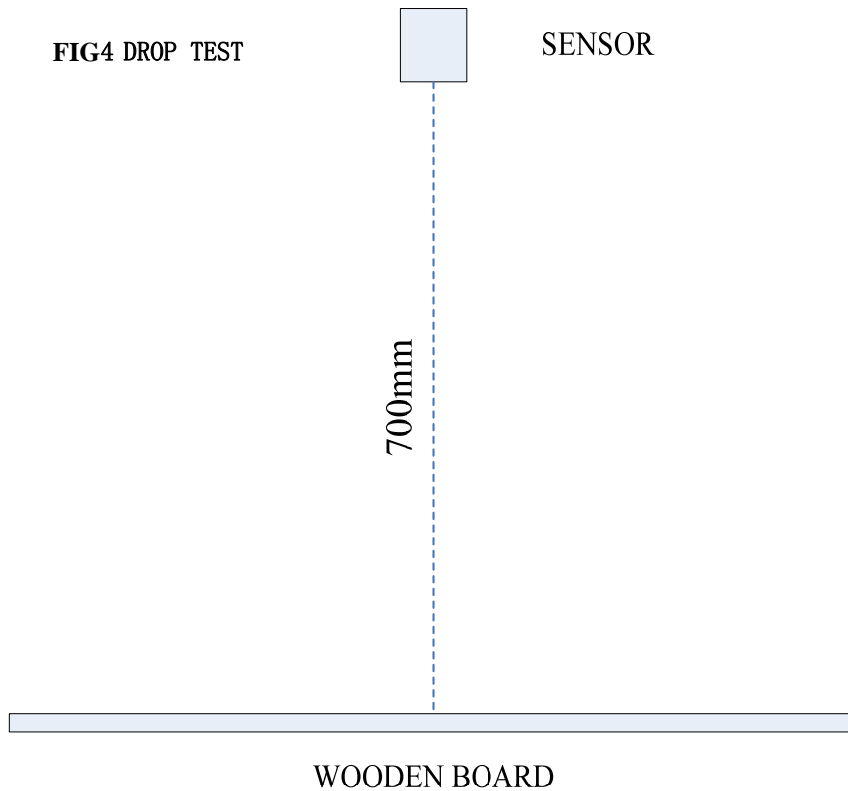

FIG4 DROP TEST



NOTE备注:

1. DESIGN RESTRICTION/PRECAUTIONS 设计限制/预防

■ This sensor is designed for use in air environment. Do not use it in liquid.

该探头是按照应用于空气环境而设计的，禁止用于液体环境。

■ In the case where secondary accidents due to operation failure or malfunctions can be anticipated, add a fail safe function to the design.

为了防止归于操作失败或者故障所致的可预测的次要事故，给设计增加一个失效安全功能。

■ In the case where this sensor is to be shocked or impacted, fit a “V” wave-guide on the sensor (see the following drawing), which also is to improve receiving sensitivity .

为了防止探头受到外力的冲击或挤压，并加强探头的接收能力，应给探头加上V型波导管。如图示：

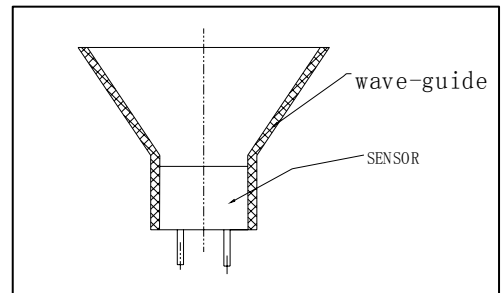

2. USAGE RESTRICTION/PRECAUTIONS使用限制/预防:

■ To prevent sensor malfunctions, operational failure or any deterioration of its characteristics, do not use this sensor in the following, or similar conditions:

为了防止探头故障，操作失败，或者其任何性能退化，禁止使用本探头于以下情况或者相似环境条件：

- a) In strong shock or vibration. 强烈的冲击或者振荡情况；
- b) In high temperature and humidity for a long time. 长时间处于高温高湿的环境；
- c) In corrosive gases or sea breeze. 腐蚀气体或者海风环境；
- d) In an atmosphere of organic solvents. 有机溶剂环境；
- e) In dirty and dusty environments that may contaminate the sensor front.
可能污染探头顶部的肮脏、灰尘环境；
- f) Over specified allowable input voltage . 超过指定允许输入电压的条件。

■ Do not solder adding stress on outer lead, also do not apply stress like spin or pressure just after soldering. In case you form the leads, support the root firmly.

禁止在焊接插针脚时施加应力和刚焊接后施加旋转应力或压应力。在焊接引线时，应紧紧地支撑住根部。

3. WARRANTY保证:

■ Time limit使用期限

Warranty period is one year after delivery. 交货后一年内。

■ Scope范围

Defective sensors attributable to manufacturer' responsibility shall be replaced for free during the warranty period. However, following cases are out of the scope.

在保证期内，由于我司责任造成的有缺陷的探头，可免费更换。但是，以下情况在这范围之外：

- a) Unsuitable handling or misuse by user. 使用者不合理的处理或者误用；
- b) Modification or repair by user. 使用者的修改或者修理；
- c) Any other cases not due to manufacturer' responsibility such as natural calamity, accident .etc.

不归于我司责任的其它任何情况，譬如自然灾害和事故等；

This scope covers only replacement. 此范围仅适用于更换。

Any loss derived from failure or malfunction of the sensor, or cost on replacing is excluded from this warranty scope. 源于探头失效或者故障的任何损失，或替换费用排除在此保证范围之外。